



Parts List

- 1 - (A) Seat Assembly
- 1 - (B) Back Assembly
- 1 - (C) Headboard
- 2 - (D) Glider Base
- 2 - (E) Bearing Arm Supports
- 2 - (F) Armrest's
- 1 - (G) Back Crosspiece (Short)
- 1 - (H) Front Crosspiece (Long)
- 2 - (I) Crosspiece Supports
- 2 - (J) Lintels

Hardware

- 2 - 5/16" x 3 1/2" Stainless Wafer Bolts
- 2 - 5/16" x 2 1/2" Stainless Wafer Bolts
- 8 - 5/16" x 2" Stainless Wafer Bolts
- 4 - Lock Nuts
- 4 - Washers
- 12 - 3" Stainless Steel Screws
- 8 - 2 1/2" Stainless Steel Screws
- 32 - 2" Stainless Steel Screws
- 8 - 1/2" Stainless Steel Screws
- 1 - 5/32 Hex key

Tools Required

- 5/32 Hex Key (Included)
- #2 Square Drive Bit (Not Included)
- 9/16" Wrench (Not Included)

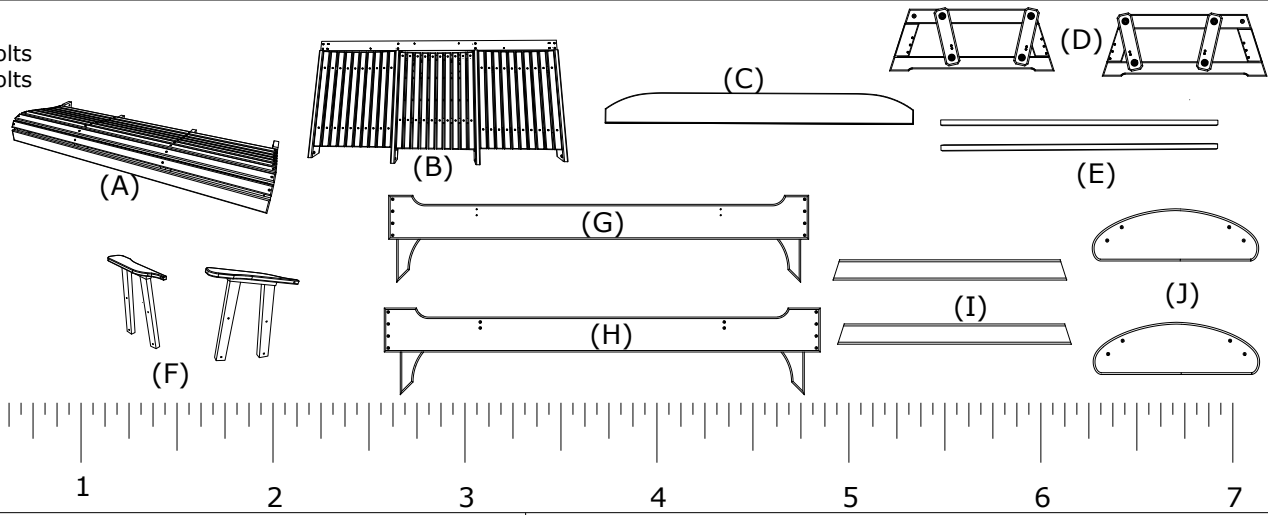

1. Attach (G) Back Crosspiece (Short) and (H) Front Crosspiece (Long) to (D) Glider Base's Using 8 - 2" and 6 - 3" Screws per side, be sure to match all numbers & or letters.

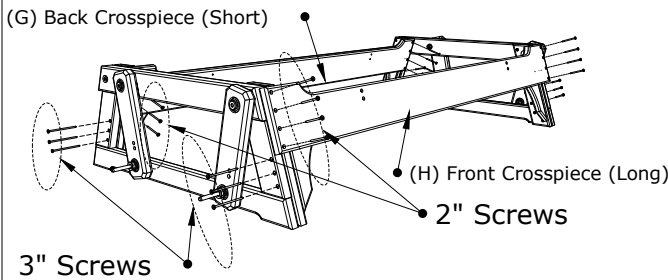

2. Attach (I) Crosspiece Supports to Front-Back Crosspieces using 4 - 2" Screws per side, be sure to match all numbers & or letters.

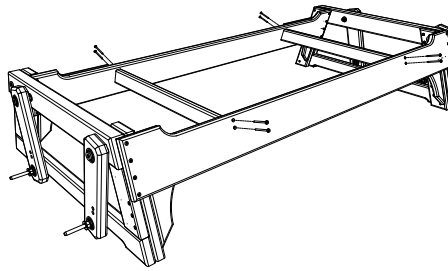

3. Attach (E) Bearing Arm Supports to Glider Base using 4 - 2 1/2" Screws per side, be sure to match all numbers & or letters.

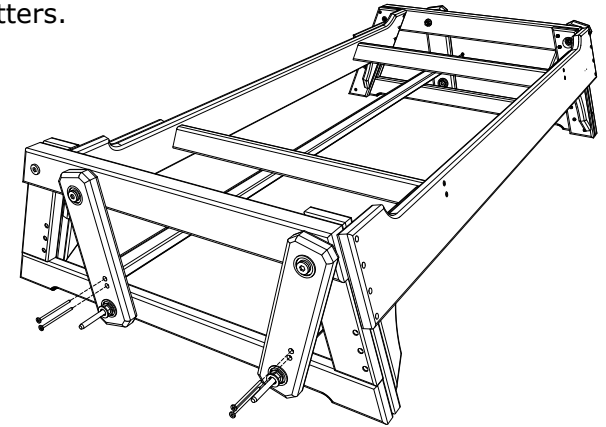

4. Attach (F) Armrests to Glider Base using (2-Washers)&(2-Nuts) per side, be sure to match all numbers & or letters. "Assembly order is Armrest Assembly-Washer-Nut"

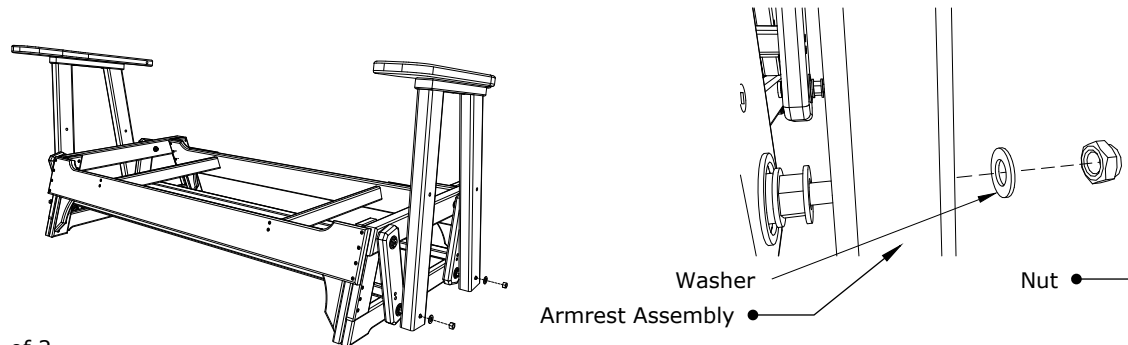

5' Classic Poly Glider Assembly Instructions

03/2/ 2020

R.M.



5. Attach (C) Headboard to (B) Back Assembly using 8 - 1/2" Screws, be sure to match all numbers and or letters.

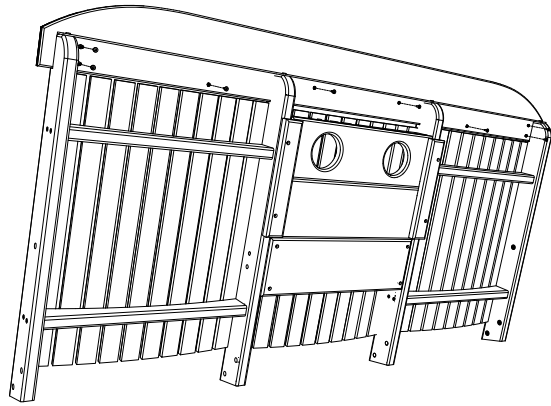

6. Attach (B) Back Assembly to (A) Seat Assembly using 6 - 2" Wafer Bolts, be sure to Match all numbers & or letters, tighten Wafer Bolts with included Hex Key.

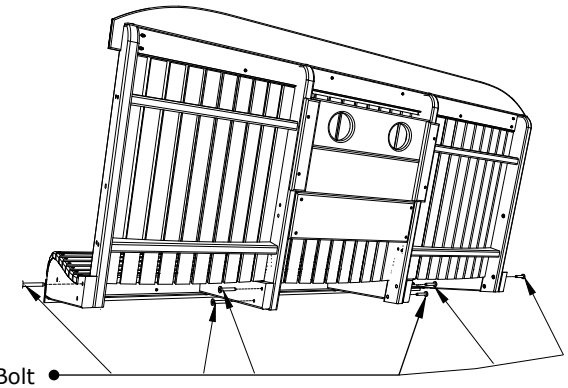

7. Attach Back-Seat Assembly to Armrests using
1 - 3 1/2" Wafer Bolt
1 - 2 1/2" Wafer Bolt &
1 - 2" Wafer Bolt
per side, be sure to match all numbers & or letters, tighten Wafer Bolts with included Hex Key.

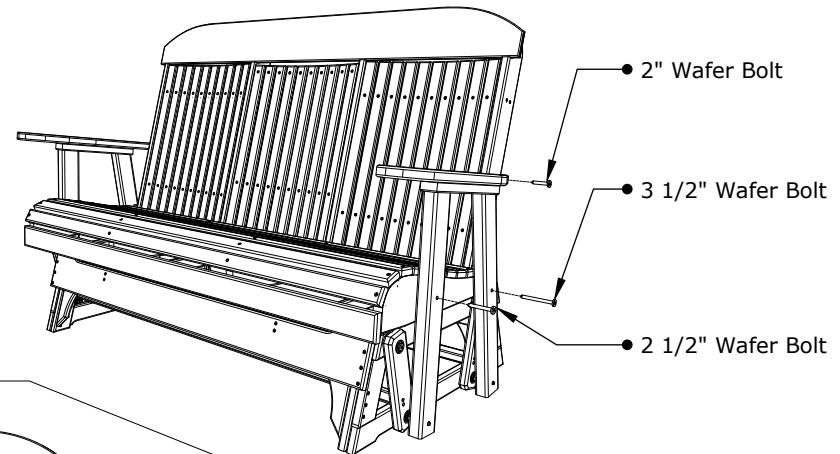

8. Attach (J) Lintels to Armrest Assemblies using 4 - 2" Screws per side, be sure to match all numbers & or letters.

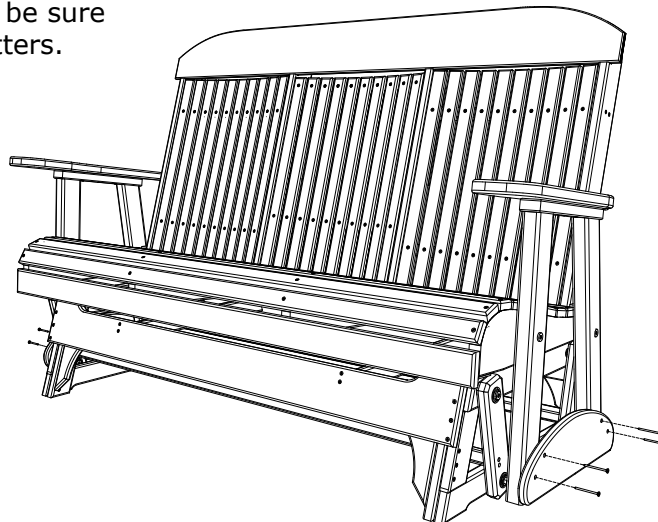

5' Classic Poly Glider Assembly Instructions

03/2/ 2020

R.M.